

PA8201 MANUAL~TABLE OF CONTENTS

- 1. SPECIFICATIONS
- 2. FEATURES
- 3. PANELS
- 4. OPERATION
- 5. FUNCTIONS
- 6. RS232C INTERFACE

1. SPECIFICATIONS

- 1.1 Output signal range□ $-3.1000 \square +3.1000 \text{mV/V}$
- 1.2 Minimum step length□ 0.0001mV/V
- 1.3 Linearity□ $0.01\% \text{FS}$
- 1.4 Display□ LCD (122×32 dot-matrix, with back-light, Black characters on green light background)
- 1.5 Current Consumption□ 80 mA DC (with back-light)
40 mA DC (without back-light)□

2. FEATURES

- 2.1 Menu Mode
- 2.2 RS232C Interface
- 2.3 Display Back-light
- 2.4 Auto Power Off
- 2.5 Beeper
- 2.6 Baud Rate

2.7 Load Cell Bridge Resistance Selection

2.8 Excitation voltage: 5~12VDC

3. PANELS

3.1 Front Panel□

Back Panel□

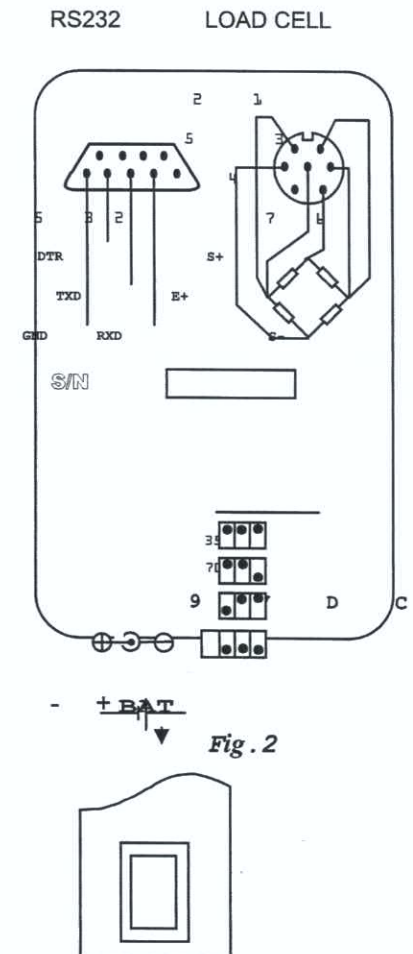
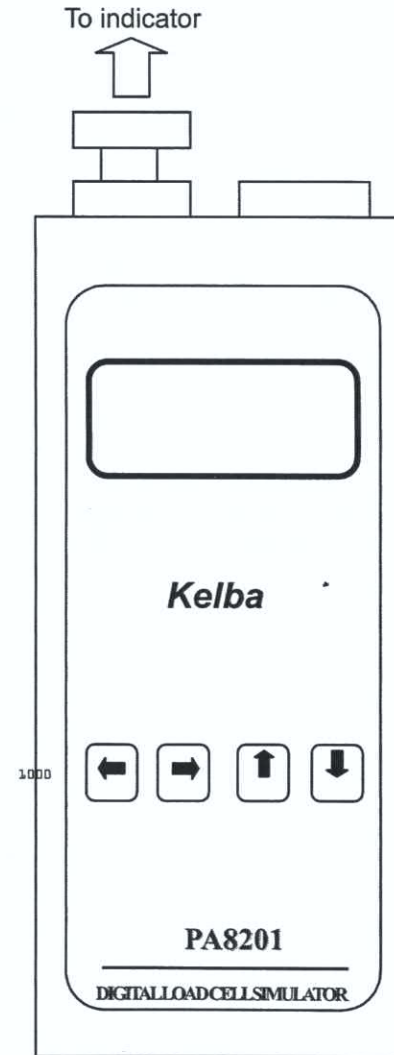

Fig.4

3

then shows in the following automatically after 3 seconds

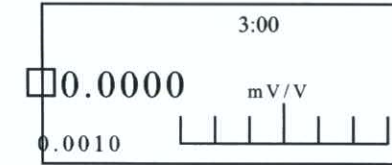

Fig.5

4.2 Normal operation mode

4.2.1 The display in normal operation mode is as Fig.5

Signal area (Top left corner)

Display strength of output signal

For example: If display is 1.0000mV/V and excitation voltage is 10V, then the output voltage is 10mV

Timer for auto power off (Top right corner)

Simulator will power off automatically, when timer counts down to zero and sounds alarm, for a period of no-key press.

Step length area (Bottom left corner)

Adjust a different output signal when press key (increase) or key

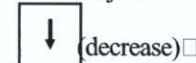

(decrease)

Bar-graph area (Bottom right corner)

The bar graph will increase a step when the output signal increases 0.1000mV/V.

4.2.2 Function keys



Press this key once to increase output signal one step

0
1

Fig.1

2

3.2 Dimension 170×75×300 (mm)

3.3 Signal Output Cable Wiring:

Pin1 +Excitation (+E)

Pin4 - Excitation (-E)

Pin2 +Signal (+S)

Pin3 -Signal (-S)

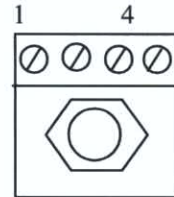

Fig.3

3.4 RS232 serial output (9 pin) wiring

2 → RXD

3 → TXD

4 → DTR

5 → GND

3.5 Back panel DIP switch for input resistor setting

Upper is ON, Lower is OFF

| Input resistance (Ohm) | Switch1 | Switch2 | Switch3 | Switch4 |
|------------------------|---------|---------|---------|---------|
| 350 | none | ON | ON | ON |
| 700 | none | ON | ON | OFF |
| 1000 | none | OFF | ON | ON |
| 2000 | none | OFF | OFF | OFF |

3.6 Recharge time for battery 10 hours

4 OPERATION

4.1 Power on and initial display

Put power supply switch to 1(ON) (see Fig.3) and press key,

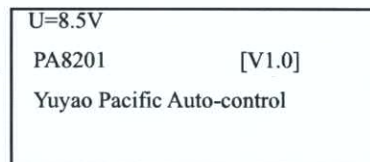

 Press this key once to decrease output signal one step

4

 Press this key once to increase output by 10 steps

 Press this key once to decrease output by 10 steps

 Press this key and hold, the output signal will zero after beeping 3 times



  Press these two keys simultaneously to enter menu setting mode



5 FUNCTION MENU MODE

5.1 Selection of function menu

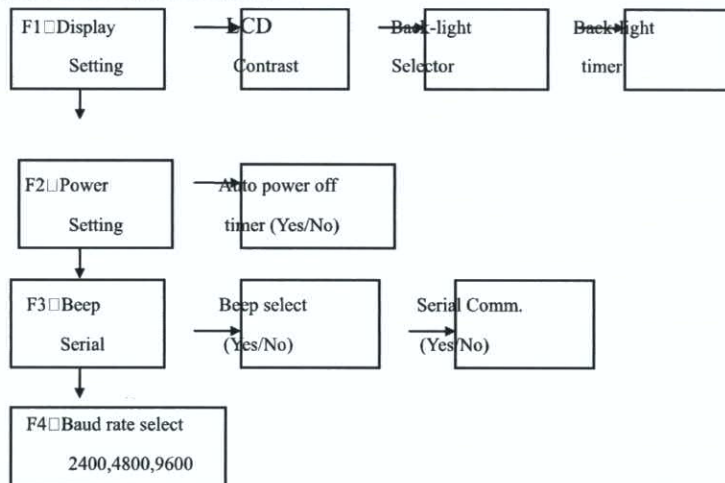

5

5.2 Function key in menu mode



 Press these two keys simultaneously in normal operation



 mode to enter menu mode



 Press this key to select sub-menu (F1 F2)



 Press this key to select a function in a sub-menu



or  Press this key to change the selection of functions



5.3 Display in function menu mode

5.3.1 F1 (for display)

Note: Cursor "→" in figures as follows is indicating the selection

| | |
|---------------|-------|
| (1) Indicator | 3:00 |
| Contrast | 1 |
| Back Light | Yes |
| → B.Light off | 3 sec |

Fig.7

Press  key to enter F2

5.3.2 F2 (for power)

6

| | |
|-------------|-------|
| (2)Power | 3:00 |
| → Auto down | 3 Min |

Fig.8

Press  key to enter F3

5.3.3 F3(for keyboard)

| | | |
|-----------------|------|------------------|
| (3) keyboard | 3:00 | |
| → Beep on touch | Yes | |
| Auto-back | Yes | RS232 selectable |

Fig.9

Press  key to enter F4

5.3.4 F4

| | |
|------------|------|
| RS 232 | 3:00 |
| →Baud rate | 9600 |

Fig.10

Press  key to exit function menu mode

6 RS-232C COMMUNICATION

6.1 RS 232C wiring

| Signal Generator | | Serial Port of Computer | | |
|------------------|------|-------------------------|--------|------|
| X2 | Line | 25 pins | 9 pins | Line |
| 3 | TXD | 3 | 2 | RXD |
| 2 | RXD | 2 | 3 | TXD |
| 4 | DTR | 20 | 4 | DTR |
| 5 | GND | 7 | 5 | GND |

6.2 RS-232C parameter settings

Baud rate 2400/4800/9600

Check bit None

Stop bit 1

Data bit 8

6.3 Communication Protocol

Sign

ESC 27 (decimal)

CR 13 (decimal)

LF 10 (decimal)

XXXX—signal, in hexadecimal

xxxx —step length, in hexadecimal

6.4 Communication Rules

Signal transmit range -3.1000+3.1000mV/V

Step length transmit range 0.0001 1.0000mV/V

Decimal point is fixed, none transmit

Characters transmitted are “0, 1, 2, 3, 4, 5, 6, 7, 8, 9, S, s, ”

Transmit from higher byte to low, the front is for signal; the following 5 bytes are for step length.

For example

Signal is +2.1234 and step length is 0.1000, then transmit as below,

ESC S: +21234 s: 01000 CR LF